

Dell™ 2400MP Projector

User's Guide

Notes, Notices, and Cautions



NOTE: A NOTE indicates important information that helps you make better use of your projector.



NOTICE: A NOTICE indicates either potential damage to hardware or loss of data and tells you how to avoid the problem.



CAUTION: A CAUTION indicates a potential for property damage, personal injury, or death.

Information in this document is subject to change without notice.

© 2007-2008 Dell Inc. All rights reserved.

Reproduction in any manner whatsoever without the written permission of Dell Inc. is strictly forbidden.

Trademarks used in this text: *Dell* and the *DELL* logo are trademarks of Dell Inc.; *DLP* and *DLP*® logo are trademarks of Texas Instruments; *Microsoft* and *Windows* are either registered trademarks or trademarks of Microsoft Corporation in the United States and/or other countries.

Other trademarks and trade names may be used in this document to refer to either the entities claiming the marks and names or their products. Dell Inc. disclaims any proprietary interest in trademarks and trade names other than its own.

Model 2400MP

May 2008 Rev. A02

Contents

1	Your Dell Projector	5
	About Your Projector	7
2	Connecting Your Projector	8
	Connecting to a Computer	9
	Connecting to a DVD Player	10
	Connecting a DVD Player with an S-video Cable	10
	Connecting a DVD Player with a Composite Cable	11
	Connecting a DVD Player with a Component Cable	12
	Professional Installation Options:	13
3	Using Your Projector	14
	Turning Your Projector On	14
	Turning Your Projector Off	14
	Adjusting the Projected Image	15
	Raising the Projector Height	15
	Lowering the Projector Height	15
	Adjusting the Projector Zoom and Focus	16
	Adjusting Projection Image Size	17
	Using the Control Panel	18

Using the Remote Control	20
Using the On-Screen Display	21
Main Menu	22
Input Select	22
Auto-Adjust	22
Set Up	22
PICTURE (in PC Mode)	24
PICTURE (in Video Mode)	24
DISPLAY (in PC Mode)	25
DISPLAY (in Video Mode)	26
LAMP	26
LANGUAGE	27
Preferences	28
4 Troubleshooting Your Projector	31
Changing the Lamp	35
5 Specifications	37
Contacting Dell	42
6 Appendix: Glossary	43

Your Dell Projector

Your projector comes with all the items shown below. Ensure that you have all the items, and contact Dell if anything is missing.

Package Contents

1.8m power cord (3.0m in Americas)

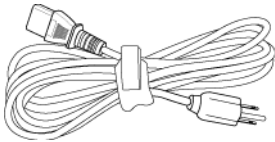

1.8m VGA cable (D-sub to D-sub)

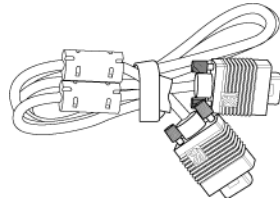

1.8m USB cable

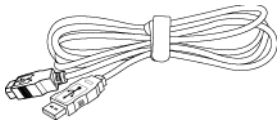

1.8m D-sub to YPbPr cable

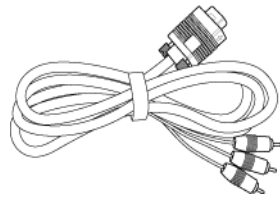

2.0m S-video cable

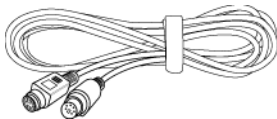

1.8m Composite Video cable

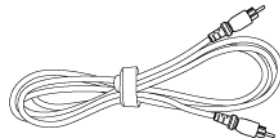

Package Contents *(continued)*

1.8m RCA to Audio cable

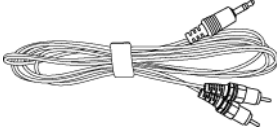

1.8m mini pin to mini pin cable

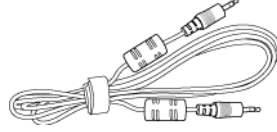

Batteries (2)

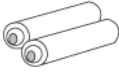

Remote control



Documentation



Carrying case



About Your Projector

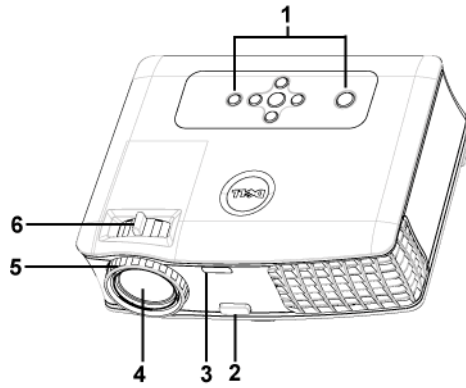

1	Control panel
2	Elevator button
3	Remote control receiver
4	Lens
5	Focus ring
6	Zoom tab

2

Connecting Your Projector

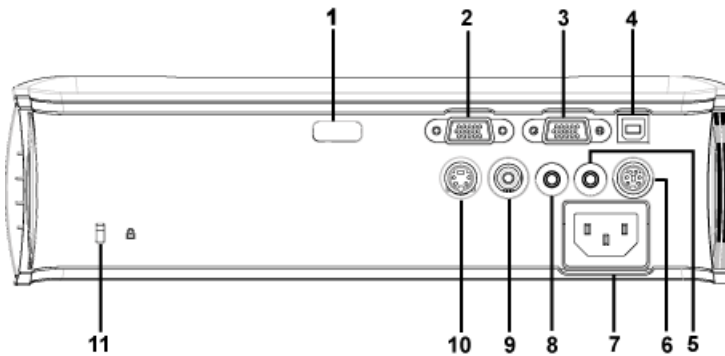

1	IR receiver
2	VGA in (D-sub) connector
3	VGA out (monitor loop-through)
4	USB remote connector
5	Audio output connector
6	RS232 connector
7	Power cord connector
8	Audio input connector
9	Composite video connector
10	S-video connector
11	Kensington lock hole

Connecting to a Computer

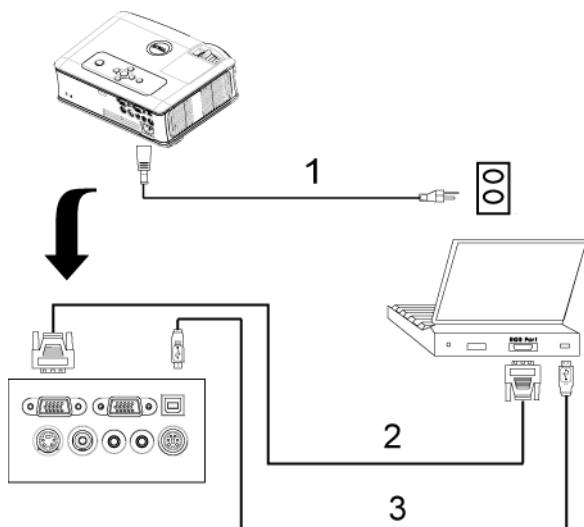

1	Power cord
2	D-sub to D-sub cable
3	USB to USB cable

Connecting to a DVD Player

Connecting a DVD Player with an S-video Cable

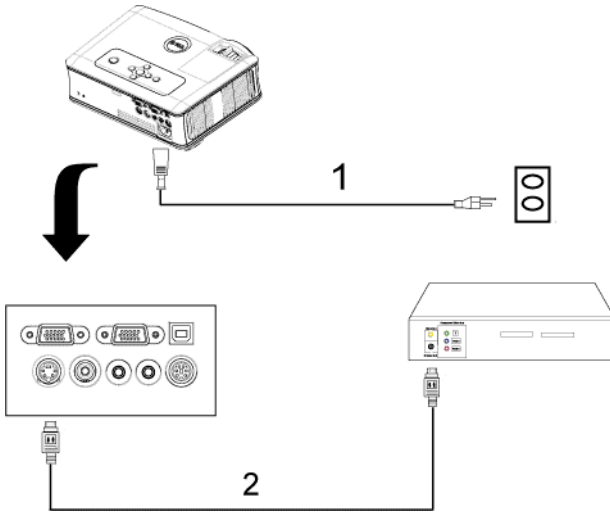

1	Power cord
2	S-video cable

Connecting a DVD Player with a Composite Cable

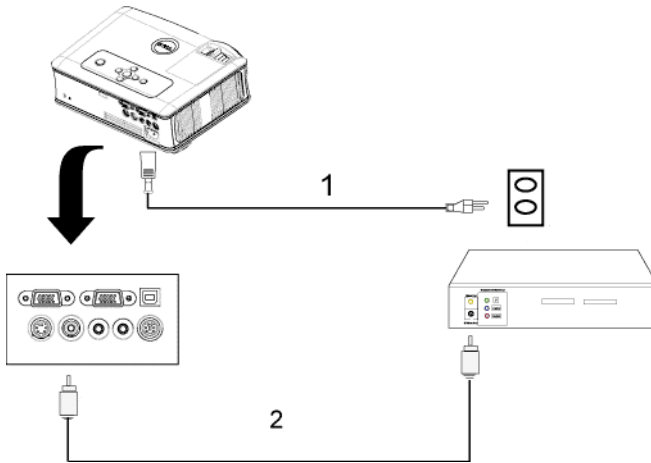

1	Power cord
2	Composite video cable

Connecting a DVD Player with a Component Cable

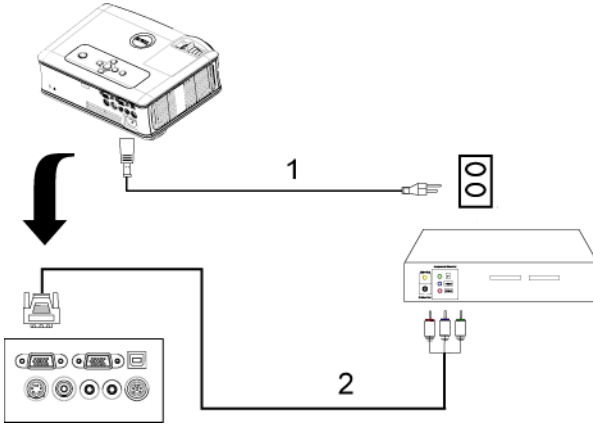

1	Power cord
2	D-sub to YPbPr cable

Professional Installation Options:

Connecting a Computer with a RS232 cable

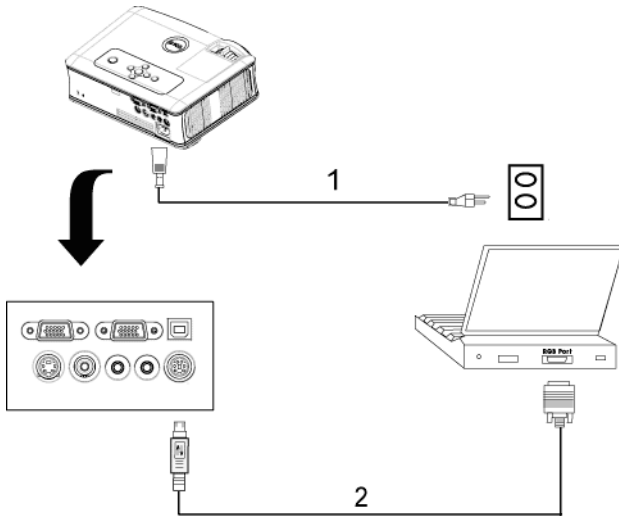

1	Power cord
2	RS232 cable

Using Your Projector

Turning Your Projector On

 **NOTE:** Turn on the projector before you turn on the source. The power button light blinks blue until pressed.

- 1 Remove the lens cap.
- 2 Connect the power cord and appropriate signal cables. For information about connecting the projector, see "Connecting Your Projector" on page 8.
- 3 Press the power button (see "Using the Control Panel" on page 18 to locate the power button). The Dell logo displays for 30 seconds.
- 4 Turn on your source (computer, DVD player, etc.). The projector automatically detects your source.

If the "Searching for signal..." message appears on the screen, ensure that the appropriate cables are securely connected.

If you have multiple sources connected to the projector, press the **Source** button on the remote control or control panel to select the desired source.

Turning Your Projector Off

 **NOTE:** Unplug the projector after properly shutting down as explained in the following procedure.

- 1 Press the power button.
- 2 Press the power button again. The cooling fans continue to operate for 90 seconds.
- 3 To power off the projector quickly, press the Power button while the projectors cooling fans are still running.

 **NOTE:** Before you turn on the projector again, wait for 60 seconds to allow the internal temperature to stabilize.

- 4 Disconnect the power cord from the electrical outlet and the projector.

NOTE: If you press the power button while the projector is running, the "Power Off the Lamp?" message appears on the screen. To clear the message, press any button on the control panel or ignore the message; the message disappears after 5 seconds.

Adjusting the Projected Image

Raising the Projector Height

- 1 Press the elevator button.
- 2 Raise the projector to the desired display angle, and then release the button to lock the elevator foot into position.
- 3 Use the tilt adjustment wheel to fine-tune the display angle.

Lowering the Projector Height

- 1 Press the elevator button.
- 2 Lower the projector, and then release the button to lock the elevator foot into position.

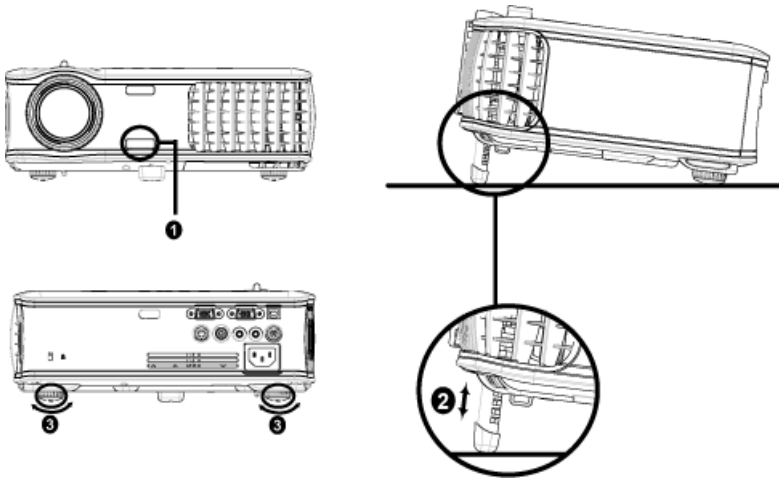

1	Elevator button
2	Elevator foot
3	Tilt adjustment wheel

Adjusting the Projector Zoom and Focus

⚠ CAUTION: To avoid damaging the projector, ensure that the zoom lens and elevator foot are fully retracted before moving the projector or placing the projector in its carrying case.

- 1 Rotate the zoom tab to zoom in and out.
- 2 Rotate the focus ring until the image is clear. The projector focuses at distances from 3.9 ft to 39.4 ft (1.2 m to 12 m).

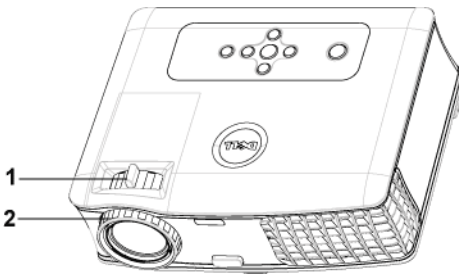

1	Zoom tab
2	Focus ring

Adjusting Projection Image Size

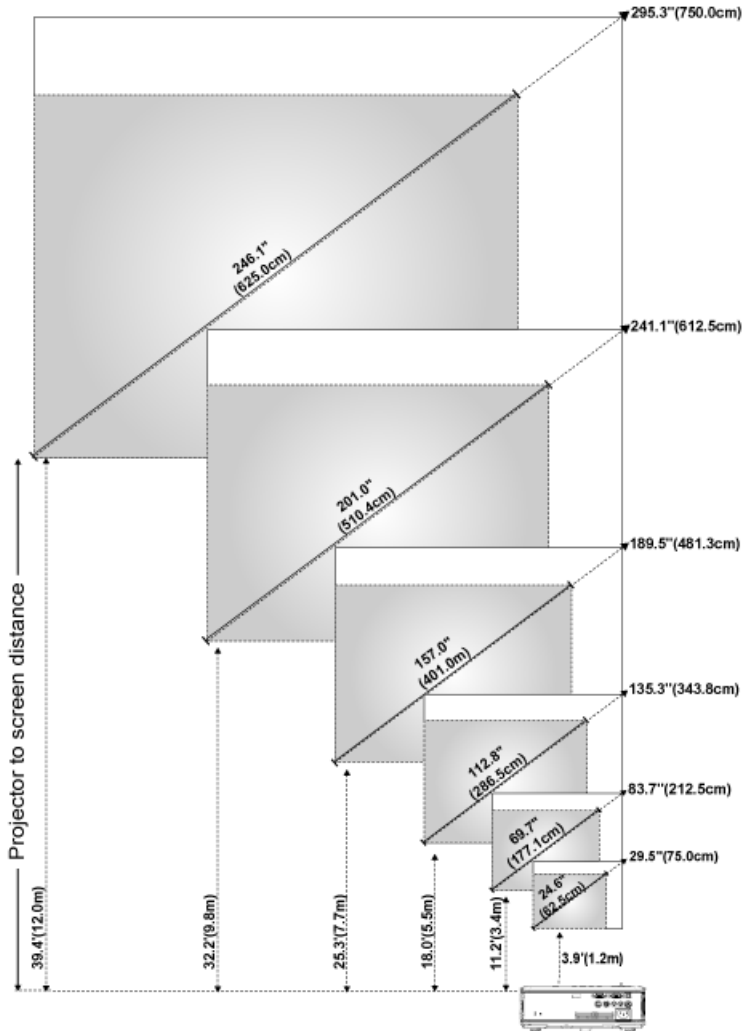



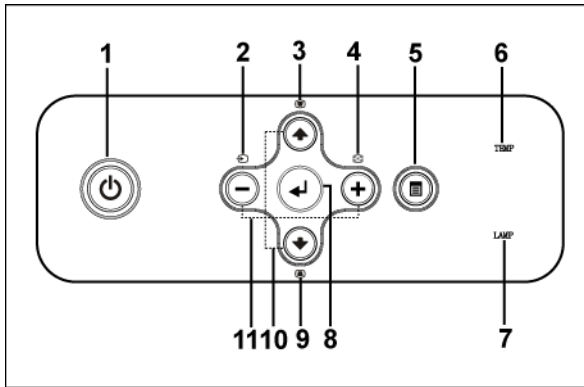

Screen (Diagonal)	Max.	29.5" (75.0 cm)	83.7" (212.5 cm)	135.3" (343.8 cm)	189.5" (481.3 cm)	241.1" (612.5 cm)	295.3" (750.0 cm)
	Min.	24.6" (62.5 cm)	69.7" (177.1 cm)	112.8" (286.5 cm)	157.0" (401.0 cm)	201.0" (510.4 cm)	246.1" (625.0 cm)
Screen Size	Max. (WxH)	23.6" x 17.7"	66.9" x 50.2"	108.3" x 81.2"	151.6" x 113.7"	192.9" x 144.7"	236.2" x 177.2"
		60.0 cm x 45.5 cm	170.0 cm x 127.5 cm	275.0 cm x 206.3 cm	385.0 cm x 288.8 cm	490.0 cm x 367.5 cm	600.0 cm x 450.0 cm
	Min. (WxH)	19.7" x 14.8"	55.8" x 41.8"	90.2" x 67.7"	126.3" x 94.7"	160.8" x 120.6"	196.9" x 147.6"
		50.0 cm x 37.5 cm	141.7 cm x 106.3 cm	229.2 cm x 171.9 cm	320.8 cm x 240.6 cm	408.3 cm x 306.3 cm	500.0 cm x 375.0 cm
Distance		3.9' (1.2 m)	11.2' (3.4 m)	18.0' (5.5 m)	25.3' (7.7 m)	32.2' (9.8 m)	39.4' (12.0 m)
* This graph is for user reference only.							

Using the Control Panel





- | | | |
|---|--------|---|
| 1 | Power | Turn the projector on and off. For more information, see "Turning Your Projector On" on page 14 and "Turning Your Projector Off" on page 14. |
| 2 | Source | Press to toggle through Analog RGB, Composite, Component-i, S-video, and Analog YPbPr sources when multiple sources are connected to the projector. |

3	Keystone adjustment	Press to adjust image distortion caused by tilting the projector. (± 40 degrees)
4	Resync	Press to synchronize the projector to the input source. Resync does not operate if the on-screen display (OSD) is displayed.
5	Menu	Press to activate the OSD. Use the directional keys and Menu button to navigate through the OSD.
6	TEMP warning light	<ul style="list-style-type: none"> • A solid orange TEMP light indicates that the projector has overheated. The display automatically shuts down. Turn the display on again after the projector cools down. If the problem persists, contact Dell. • A blinking orange TEMP light indicates that a projector fan has failed and the projector automatically shuts down. If the problem persists, contact Dell.
7	LAMP warning light	If the LAMP light is solid orange, replace the lamp. If the LAMP light is blinking orange, the system has failed and the projector will automatically shut down. If this problem persists, contact Dell.
8	Enter	Press to confirm the selection item.
9	Keystone adjustment	Press to adjust image distortion caused by tilting the projector. (± 40 degrees)
10	Up  and  Down	Press to select the OSD items.
11	 and  buttons	Press to adjust the OSD setting.

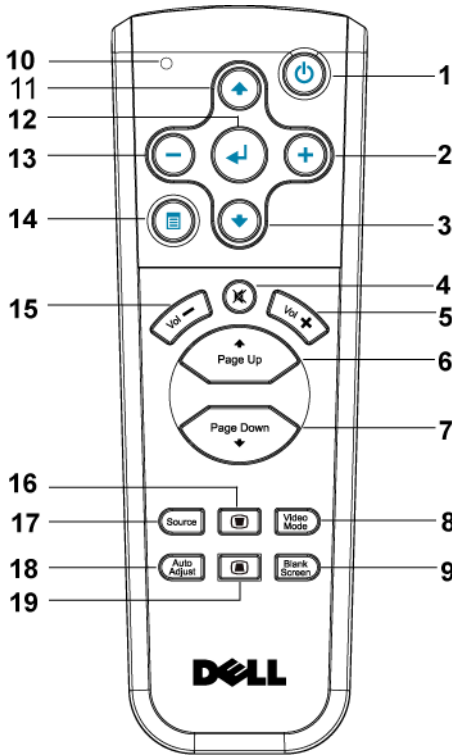
Using the Remote Control









1	Power	Turn the projector on and off. For more information, see "Turning Your Projector On" on page 14 and "Turning Your Projector Off" on page 14.
2	+	Press to adjust the OSD setting.
3	Down button ↓	Press to select OSD items.
4	Mute	Press to mute or un-mute the projector speaker.
5	Volume +	Press to increase the volume.
6	Page ↑	Press to move to previous page.
7	Page ↓	Press to move to next page.

8	Video mode	The Dell 2400MP Micro-projector has preset configurations that are optimized for displaying data (PC Graphics) or video (movies, games, etc.). Press Video Mode button to toggle between PC mode , Movie mode , Game Mode , sRGB , or CUSTOM mode (for user to setup and save preferred settings). Pressing the Video Mode button once will show the current display mode. Pressing the Video Mode button again will switch between modes.
9	Blank screen	Press to hide the image, press again to resume display of the image.
10	LED light	LED indicator.
11	Up button 	Press to select OSD items.
12	Enter button	Press to confirm the selection.
13		Press to adjust the OSD setting.
14	Menu	Press to activate the OSD.
15	Volume 	Press to decrease the volume.
16	Keystone adjustment	Press to adjust image distortion caused by tilting the projector. (± 40 degrees)
17	Source	Press to switch between Analog RGB, Digital RGB, Composite, Component-i, S-video, and Analog YPbPr sources.
18	Auto adjust	Press to synchronize the projector to the input source. Auto adjust does not operate if the OSD (On-Screen Display) is displayed.
19	Keystone adjustment	Press to adjust image distortion caused by tilting the projector. (± 40 degrees)

Using the On-Screen Display

The projector has a multi-language On-Screen Display (OSD) that can be displayed with or without an input source present.

In the Main Menu, press  or  to navigate through the tabs. Press Enter button on the control panel or the remote control to select a submenu.

In the submenu, press  or  to make a selection. When an item is selected, the color changes to dark gray. Use  or  on the control panel or the remote

control to make adjustments to a setting.

To go back to Main Menu, go to BACK tab and press Enter button on the control panel or the remote control.

To exit the OSD, go to Exit tab and press Enter button on the control panel or the remote control.

Main Menu

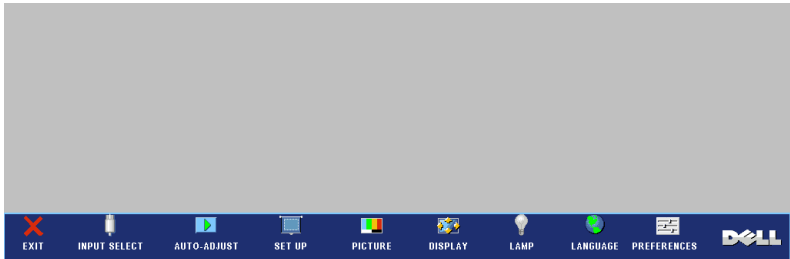

Input Select

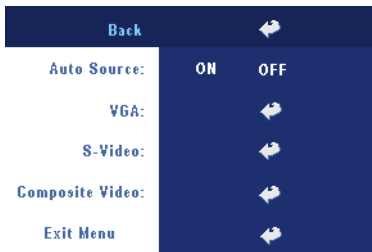

AUTO SOURCE—Select ON (the default) to autodetect the available input signals.

When the projector is on and you press SOURCE, it automatically finds the next available input signal. Select OFF to lock the current input signal. When OFF is selected and you press SOURCE, you select which input signal you want to use.

VGA—Press ENTER to detect VGA signal.

S-VIDEO—Press ENTER to detect S-Video signal.

COMPOSITE VIDEO—Press ENTER to detect Composite Video signal.

Auto-Adjust



Select to show "Auto Adjustment in Progress..." information.

Set Up





H. KEYSTONE—Adjust image distortion caused by horizontal shifting of the projector orientation.



V. KEYSTONE—Adjust image distortion caused by tilting the projector.

AUTO KEYSTONE—Auto adjust the image distortion by tilting the projector.

PROJECTOR MODE—Select how the image appears:

-  Front Projection-Desktop (the default).
-  Front Projection-Ceiling Mount — The projector turns the image upside down for ceiling-mounted projection.
-  Rear Projection-Desktop — The projector reverses the image so you can project from behind a translucent screen.
-  Rear Projection-Ceiling Mount — The projector reverses and turns the image upside down. You can project from behind a translucent screen with a ceiling-mounted projection.

ASPECT RATIO—Select an aspect ratio to adjust how the image appears.

- 1:1 — The input source displays without scaling.
Use 1:1 aspect ratio if you are using one of the following:
 - VGA cable and the computer has a resolution less than XGA (1024 x 768)
 - Component cable (576p/480i/480p)
 - S-Video cable
 - Composite cable
- 16:9 — The input source scales to fit the width of the screen.
- 4:3 — The input source scales to fit the screen.
Use 16:9 or 4:3 if you are using one of the following:
 - Computer resolution greater than XGA
 - Component cable (1080i or 720p)

PROJECTOR INFO—Press to show the projector model name, the present resolution and projector series number (PPID#).

PICTURE (in PC Mode)



BRIGHTNESS—Use \ominus and \oplus to adjust the brightness of the image.

CONTRAST—Use \ominus and \oplus to control the degree of difference between the brightest and darkest parts of the picture. Adjusting the contrast changes the amount of black and white in the image.

COLOR TEMP—Adjust the color temperature. The higher the temperature, the screen appears bluer; the lower the temperature, the screen appears redder. User mode activates the values in the "color setting" menu.

COLOR ADJUST—Manually adjust red, green, and blue color.

PICTURE (in Video Mode)



BRIGHTNESS—Use \ominus and \oplus to adjust the brightness of the image.

CONTRAST—Use \ominus and \oplus to control the degree of difference between the brightest and darkest parts of the picture. Adjusting the contrast changes the amount of black and white in the image.

COLOR TEMP—Adjust the color temperature. The higher the temperature, the screen appears bluer;

the lower the temperature, the screen appears redder. User mode activates the values in the "color setting" menu.

COLOR ADJUST—Manually adjust red, green, and blue color.

SATURATION—Adjust a video source from black and white to fully saturated color. Press \ominus to decrease the amount of color in the image and \oplus to increase the amount of color in the image.

SHARPNESS—Press \ominus to decrease the sharpness and \oplus to increase the sharpness.

TINT—Press \ominus to increase the amount of green in the image and \oplus to increase the amount of red in the image.

DISPLAY (in PC Mode)

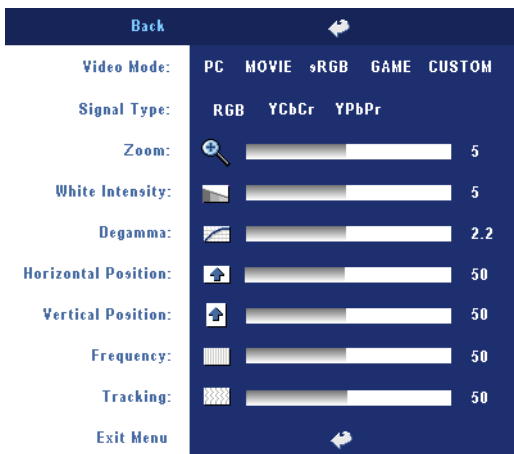

VIDEO MODE—Select a mode to optimize the display on how the projector is being used: **PC**, **MOVIE**, **sRGB** (provides more accurate color representation), **GAME**, and **CUSTOM** (set your preferred settings). If you adjust the settings for **White Intensity** or **Degamma**, the projector automatically switches to **CUSTOM**.

SIGNAL TYPE—Manually select signal type **RGB**, **YCbCr**, **YPbPr**.

ZOOM—Press \oplus to digitally magnify an image to 10 times on the projection screen and press \ominus to reduce the zoomed image.

WHITE INTENSITY—Setting 0 to maximize the color reproduction and 10 to maximize the brightness.

DEGAMMA—Adjust among the 4 preset values to change the color performance of the display.

HORIZONTAL POSITION—Press \ominus to adjust the horizontal position of the image to the left and \oplus to adjust the horizontal position of the image to the right.

VERTICAL POSITION—Press \ominus to adjust the vertical position of the image down and \oplus to adjust the vertical position of the image up.

FREQUENCY—Change the display data clock frequency to match the frequency of your computer graphics card. If you see a vertical flickering bar, use **Frequency** control to minimize the bars. This is a coarse adjustment.

TRACKING—Synchronize the phase of the display signal with the graphic card. If you experience an unstable or flickering image, use **Tracking** to correct it. This is a fine adjustment.

DISPLAY (in Video Mode)

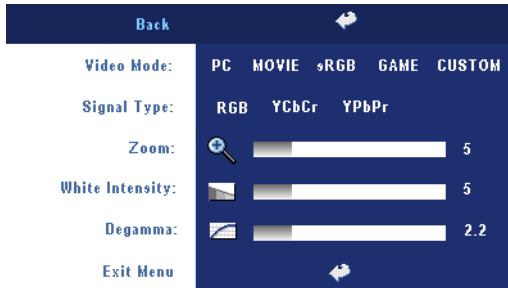

VIDEO MODE—Select a mode to optimize the display on how the projector is being used: **PC**, **MOVIE**, **sRGB** (provides more accurate color representation), **GAME**, and **CUSTOM** (set your preferred settings). If you adjust the settings for **White Intensity** or **Degamma**, the projector

automatically switches to **CUSTOM**.

SIGNAL TYPE—Manually select signal type **RGB**, **YCbCr**, **YPbPr**.

ZOOM—Press **+** to digitally magnify an image to 10 times on the projection screen and press **-** to reduce the zoomed image.

WHITE INTENSITY—Setting 0 to maximize the color reproduction and 10 to maximize the brightness.

DEGAMMA—Adjust among the 4 preset values to change the color performance of the display.

LAMP



LAMP HOUR—Display the operating hours since the lamp timer reset.

POWER SAVING—Select **ON** to set the power saving delay period. The delay period is the amount of time you want the projector to wait without signal input. After that set time,

the projector enters power saving mode and turns off the lamp. The projector turns back on when it detects an input signal or when you press the power button. After two hours, the projector turns off or when you press the power button to turn the projector on.

Eco Mode—Select **ON** to use the projector at a lower power level (230 Watts), which may provide longer lamp life, quieter operation, and dimmer luminance output on the screen. Select **OFF** to operate at normal power level (260 Watts).

LAMP RESET—After you install a new lamp, select **Yes** to reset the lamp timer.

LANGUAGE



Preferences

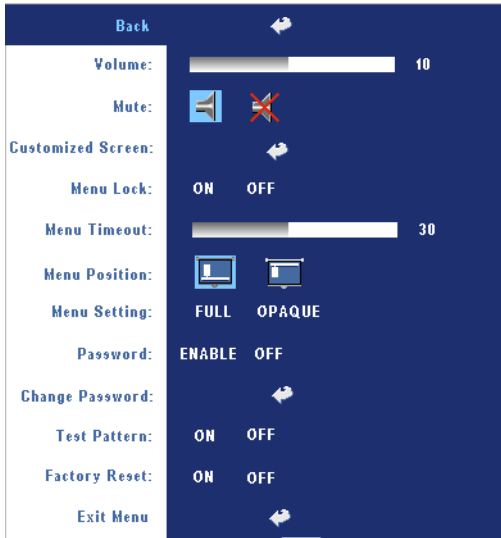

VOLUME—Press \ominus to decrease the volume and \oplus to increase the volume.

MUTE—Allows to mute the sound.

CUSTOMIZED SCREEN—Press **Enter** will pop-up a menu, then select "YES". The projector will capture the screen image as a "My Customized logo". This screen will replace all the original screens which contains Dell logo. User can recover the default screen by selecting "Dell Logo" on the pop-up screen.

MENU LOCK—Select **ON** to enable Menu Lock for hiding the OSD menu. Select **OFF** to disable the Menu Lock. If you want to disable the Menu Lock function and the OSD disappears, press the Menu button on the panel for 15 seconds, then disable the function.

MENU TIMEOUT—Adjust the time delay of the **OSD Timeout**. The Default setting is 30 seconds.

MENU POSITION—Select the location of the OSD on the screen.

MENU SETTING—Select to change the OSD background in full or opaque.

PASSWORD—Protect your projector and restrict access to it with Password Security feature. This security utility enables you to impose a variety of access restrictions to protect your privacy and stop others from tampering with your projector. This means that the projector cannot be used if it is taken without authorization, and thus serves as a theft-prevention feature.

When Password Protect is enabled (**On**), a Password Protect screen requesting you to enter a password will be displayed when the power plug is inserted into the electrical outlet and the power for the projector is first turned on. By default, this function is disabled. You can enable this feature

using the Password menu. This password security feature will be activated on the next time you turn on the projector. If you enable this feature, you will be asked to enter the projector's password after you turn on the projector:

- 1 1st time password input request:
 - a Go to **Preferences** menu, press **Enter** and then select **Password** to **ENABLE** the password setting.

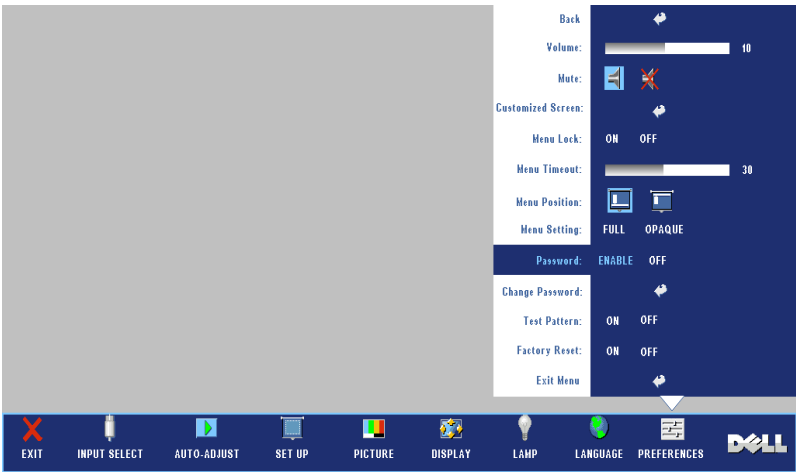

-
- b Enable the Password function will pop-up a character screen, key in a 4-digit number from the screen and press the **ENTER** button.



-
-
- c To confirm, enter the password again.
- d If the password verification is successful, you may resume with accessing the projector's functions and its utilities.

- If you have entered incorrect password, you will be given another 2 chances. After the three invalid attempts, the projector will automatically turn off.



NOTE: If you forget your password, contact your dealer or qualified service personnel.

- To cancel the password function, select **OFF** and enter the password to disable the function.



CHANGE PASSWORD—Key in the original password, then enter the new password and confirm the new password again.









TEST PATTERN—Select **ON** to activate the built-in **Test Pattern** for self-testing on focus and resolution. Select **OFF** to disable the function.

FACTORY RESET —Select **ON** to reset the projector to its factory default settings. Reset items include both computer sources and video source settings.

Troubleshooting Your Projector

If you experience problems with your projector, see the following troubleshooting tips. If the problem persists, contact Dell.

Problem	Possible Solution
No image appears on the screen	<ul style="list-style-type: none">• Ensure that the lens cap is removed and the projector is turned on.• Ensure the external graphics port is enabled. If you are using a Dell portable computer, press   (Fn+F8). For other computers, see your respective documentation.• Ensure that all the cables are securely connected. See on page 8.• Ensure that the pins of the connectors are not bent or broken.• Ensure that the lamp is securely installed (see on page 35).• Use Test Pattern in the Preferences menu. Ensure that the colors of the test pattern are correct.

Problem (continued)	Possible Solution (continued)
Partial, scrolling, or incorrectly displayed image	<ol style="list-style-type: none"> 1 Press the Resync button on the remote control or the control panel. 2 If you are using a Dell portable computer, set the resolution of the computer to XGA (1024 x 768): <ol style="list-style-type: none"> a Right-click the unused portion of your Windows desktop, click Properties and then select Settings tab. b Verify the setting is 1024 x 768 pixels for the external monitor port. c Press   (Fn+F8). <p>If you experience difficulty in changing resolutions or your monitor freezes, restart all the equipment and the projector.</p> <p>If you are not using a Dell portable computer, see your documentation.</p>
The screen does not display your presentation	If you are using a portable computer, press   (Fn+F8).
Image is unstable or flickering	Adjust the tracking in the OSD Display tab (in PC Mode only).
Image has vertical flickering bar	Adjust the frequency in the OSD Display tab (in PC Mode only).
Image color is not correct	<ul style="list-style-type: none"> • If your graphic card output signal is sync on Green, and you would like to display VGA at 60Hz signal, please go into OSD select Display, select Signal Type and then select RGB. • Use Test Pattern in the Preferences menu. Ensure that the colors of the test pattern are correct.
Image is out of focus	<ol style="list-style-type: none"> 1 Adjust the focus ring on the projector lens. 2 Ensure that the projection screen is within the required distance from the projector (3.9 ft [1.2 m] to 39.4 ft [12 m]).

Problem (continued)	Possible Solution (continued)
The image is stretched when displaying a 16:9 DVD	<p>The projector automatically detects a 16:9 DVD and adjusts the aspect ratio to full screen with a 4:3 (letter-box) default setting.</p> <p>If the image is still stretched, adjust the aspect ratio as follows:</p> <ul style="list-style-type: none"> • If you are playing a 16:9 DVD, select 4:3 aspect ratio type on your DVD player. • If you cannot select 4:3 aspect ratio type on your DVD player, select 4:3 aspect ratio in the Set Up menu in the OSD.
Image is reversed	Select Set Up from the OSD and adjust the projector mode.
Lamp is burned out or makes a popping sound	When the lamp reaches its end of life, it may burn out and may make a loud popping sound. If this occurs, the projector does not turn back on. To replace the lamp, see on page 35.
LAMP light is solid orange	If the LAMP light is solid orange, replace the lamp.
LAMP light and Power light are blinking orange	If the LAMP light and the Power light are blinking orange, the lamp driver has failed and the projector will automatically shut down. Unplug the power cord after 3 minutes then turn the display on again. If this problem persists, contact Dell.
LAMP light is blinking orange and Power light is solid blue	If the LAMP light is blinking orange and Power light is solid blue, the system has failed and the projector will automatically shut down. Unplug the power cord after 3 minutes then turn the display on again. If this problem persists, contact Dell.
TEMP light is solid orange and Power light is solid blue	The lamp has overheated. The display automatically shuts down. Turn the display on again after the projector cools down. If the problem persists, contact Dell.

Problem (continued)	Possible Solution (continued)
TEMP light and Power light are solid orange	The lamp driver has overheated. The display automatically shuts down. Turn the display on again after the projector cools down. If the problem persists, contact Dell.
TEMP light is blinking orange	A projector fan has failed and the projector will automatically shut down. If the problem persists, contact Dell.
The OSD does not appear on the screen	Try to press the Menu button on the panel for 10 seconds to unlock the OSD. Check the Menu Lock on page 28.
The remote control is not operating smoothly or works only within a limited range	The battery may be low. Replace with 2 new AAA batteries.

Changing the Lamp

Replace the lamp when the message "Lamp is approaching the end of its useful life in full power operation. Replacement suggested! www.dell.com/lamps" appears on the screen. If this problem persists after replacing the lamp, contact Dell. For more information, see "Contacting Dell".

⚠ CAUTION: The lamp becomes very hot when in use. Do not attempt to replace the lamp until the projector has been allowed to cool down for at least 30 minutes.

- 1 Turn off the projector and disconnect the power cord.
- 2 Let the projector cool for at least 30 minutes.
- 3 Loosen the 2 screws that secure the lamp cover, and remove the cover.

⚠ CAUTION: If the lamp has shattered, be careful as broken pieces are sharp and can cause injury. Remove all broken pieces from the projector and dispose or recycle according to state, local, or federal law. Go to www.dell.com/hg for additional information.

- 4 Loosen the 2 screws that secure the lamp.

⚠ CAUTION: Do not touch the bulb or the lamp glass at any time. Projector lamps are very fragile and may shatter if touched.

- 5 Pull up the lamp by its metal handle.

✍ NOTE: Dell may require that lamps replaced under warranty be returned to Dell. Otherwise, contact your local waste disposal agency for the address of the nearest deposit site.

- 6 Replace with the new lamp.
- 7 Tighten the 2 screws that secure the lamp.
- 8 Replace the lamp cover and tighten the 2 screws.
- 9 Reset the lamp usage time by selecting "Yes" for Lamp Reset in the OSD Lamp tab. (See Lamp menu on page 27)

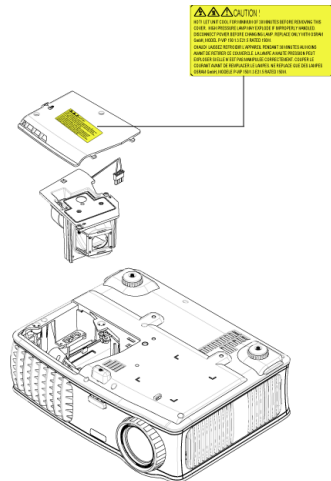



CAUTION: Lamp Disposal (for the US only)

 **LAMP(S) INSIDE THIS PRODUCT CONTAIN MERCURY AND MUST BE RECYCLED OR DISPOSED OF ACCORDING TO LOCAL, STATE OR FEDERAL LAWS. FOR MORE INFORMATION, GO TO WWW.DELL.COM/HG OR CONTACT THE ELECTRONIC INDUSTRIES ALLIANCE AT WWW.EIAE.ORG. FOR LAMP SPECIFIC DISPOSAL INFORMATION CHECK WWW.LAMPRECYCLE.ORG.**

Specifications

Light Valve	Single-chip 0.7" XGA LVDS (low-voltage differential signaling) technology
Brightness	3000 ANSI Lumens (Max.)
Contrast Ratio	2100:1 Typical (Full On/Full Off)
Uniformity	80% Typical (Japan Standard - JBMA)
Number of Pixels	1024 x 768 (XGA)
Displayable Color	16.7M colors
Color Wheel Speed	100~127.5Hz (2X)
Projection Lens	F/2.4~2.7, f=28.0~33.6 mm with 1.2x manual zoom lens
Projection Screen Size	24.6-295.3 inches (diagonal)
Projection Distance	3.9~39.4 ft (1.2 m~12 m)
Video Compatibility	NTSC, NTSC 4.43, PAL, PAL-M, PAL-N, SECAM, and HDTV (1080i, 720p, 576i/p, 480i/p) compatibility Composite video, Component video and S-video capability
H. Frequency	15kHz-92kHz (Analog)
V. Frequency	50Hz-85Hz (Analog)
Power Supply	Universal 100-240V AC 50-60Hz with PFC input
Power Consumption	325 watts typical, 285 watts in eco mode
Audio	1 speaker, 2 watt RMS
Noise Level	36 dB(A) Full-on mode, 33 dB(A) Eco-mode
Weight	<5.5 lbs (2.4 kg)

Dimensions (W x H x D)	External 10.8 x 8.3 x 4 ± 0.04 inches (273.7 x 212 x 101 ± 1 mm)
Environmental	Operating temperature: 5°C - 35°C (41°F-95°F) Humidity: 80% maximum Storage temperature: -20°C to 60°C (-4°F to 140°F) Humidity: 80% maximum
Regulatory	FCC, CE, VCCI, UL, cUL, Nemko-GS, ICES-003, MIC, C-Tick, GOST, CCC, PSB, NOM, IRAM, SABS
I/O Connectors	Power: AC power input socket Computer input: one D-sub for analog/component, HDTV input signals Computer output: one 15-pin D-sub Video input: one composite video RCA and one S-video Audio input: one phone jack (diameter 3.5 mm) Audio output: one phone jack (diameter 3.5 mm) One mini-DIN RS232 for wired remote control from PC
Lamp	260-watt user-replaceable 2000-hour lamp (up to 2500 hours in eco mode)



NOTE: The actual operating life span of a projector lamp will vary according to operating conditions and usage patterns. Usage of a projector in stressful conditions which may include dusty environments, under high temperatures and abrupt powering-off may result in a lamp's shortened operating life span or possibly lamp failure. The lamp life specified for Dell's projectors refers to the typical time under non-stressful operating conditions for more than 50% of a sampling population to reduce to approximately 50% of the lamp's rated brightness level. It is not the measure of time a lamp will cease light output.

RS232 Pin Assignment

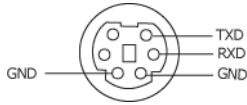

RS232 Protocol

- Communication Settings

Connection settings	Value
Baud Rate:	19200
Data Bits:	8
Parity	None
Stop Bits	1

- Command types

To pop up the OSD menu and adjust the settings.

- Control command Syntax (From PC to Projector)

[H][AC][SoP][CRC][ID][SoM][COMMAND]

- Example: Power ON Command (Send low byte firstly)

--> 0xBE, 0xEF, 0x10, 0x05, 0x00, 0xC6, 0xFF, 0x11, 0x11, 0x01, 0x00, 0x01

- Control Commands List

Go to support.dell.com to view the latest RS232 code.

Compatibility Modes

Mode	Resolution	(ANALOG)	
		V. Frequency (Hz)	H. Frequency (KHz)
VGA	640X350	70	31.5
VGA	640X350	85	37.9
VGA	640X400	85	37.9
VGA	640X480	60	31.5
VGA	640X480	72	37.9
VGA	640X480	75	37.5
VGA	640X480	85	43.3
VGA	720X400	70	31.5
VGA	720X400	85	37.9
SVGA	800X600	56	35.2
SVGA	800X600	60	37.9
SVGA	800X600	72	48.1
SVGA	800X600	75	46.9
SVGA	800X600	85	53.7
XGA	1024X768	60	48.4
XGA	1024X768	70	56.5
XGA	1024X768	75	60.0
XGA	1024X768	85	68.7
WXGA	1280X720	59.85	44.77
WXGA	1280X768	59.87	47.77
WXGA	1280X800	59.81	49.70
WXGA	1360X768	60.01	47.71
WXGA	1440X900	59.87	55.93
WSXGA+	1680X1050	59.88	64.67
WUXGA	1920X1200	49.97	64.41
*SXGA	1280X1024	60	63.98
*SXGA	1280X1024	75	79.98
*SXGA	1280X1024	85	91.1
*SXGA+	1400X1050	60	63.98
*UXGA	1600x1200	60	75
MAC LC13*	640X480	66.66	34.98
MAC II 13*	640X480	66.68	35
MAC 16*	832X624	74.55	49.725

MAC 19*	1024X768	75	60.24
*MAC	1152X870	75.06	68.68
MAC G4	640X480	60	31.35
IMAC DV	1024X768	75	60
*Compressed computer image.			

Contacting Dell

For customers in the United States, call 800-WWW-DELL (800-999-3355).



NOTE: If you do not have an active Internet connection, you can find contact information on your purchase invoice, packing slip, bill, or Dell product catalog.

Dell provides several online and telephone-based support and service options. Availability varies by country and product, and some services may not be available in your area. To contact Dell for sales, technical support, or customer service issues:

- 1 Visit support.dell.com.
- 2 Verify your country or region in the **Choose A Country/Region** drop-down menu at the bottom of the page.
- 3 Click **Contact Us** on the left side of the page.
- 4 Select the appropriate service or support link based on your need.
- 5 Choose the method of contacting Dell that is convenient for you.

Appendix: Glossary

ANSI LUMENS—A standard for measuring light output, used for comparing projectors.

ASPECT RATIO—The most popular aspect ratio is 4:3 (4 by 3). Early television and computer video formats are in a 4:3 aspect ratio, which means that the width of the image is 4/3 times the height.

BACKLIT (BACKLIGHT)—Refers to a remote control, or a projector control panel, that has buttons and controls that are illuminated.

Bandwidth—The number of cycles per second (Hertz) expressing the difference between the lower and upper limiting frequencies of a frequency band; also, the width of a band of frequencies.

Brightness—The amount of light emitting from a display or projection display or projection device. The brightness of projector is measured by ANSI lumens.

Color Temperature—A method of measuring the whiteness of a light source. Metal halide lamps have a higher temperature compared to halogen or incandescent lights.

Component Video—A method of delivering quality video in a format that contains all the components of the original image. These components are referred to as luma and chroma and are defined as Y'Pb'Pr' for analog component and Y'Cb'Cr' for digital component. Component video is available on DVD players and projectors.

Composite Video—The combined picture signal, including vertical and horizontal blanking and synchronizing signals.

Compression—A function that deletes resolution lines from the image to fit in the display area.

Compressed SVGA—To project an 800x600 image to a VGA projector, the original 800x600 signal must be compressed down. The data displays all the information with only two thirds of the pixels (307,000 vs 480,000). The resulting image is SVGA page size but sacrifices some of the image quality. If you are using an SVGA computers, connecting VGA to a VGA projector, provide better results.

Compressed SXGA—Found on XGA projectors, compressed SXGA handling allows these projectors to handle up to 1280x1024 SXGA resolution.

Compressed XGA—Found on SVGA projectors, compressed XGA handling allows these projectors to handle 1024x768 XGA resolution.

Contrast Ratio— Range of light and dark values in a picture, or the ratio between their maximum and minimum values. There are two methods used by the projection industry to measure the ratio:

1 Full On/Off — measures the ratio of the light output of an all white image (full on) and the light output of an all black (full off) image.

2 ANSI — measures a pattern of 16 alternating black and white rectangles. The average light output from the white rectangles is divided by the average light output of the black rectangles to determine the ANSI contrast ratio.

Full On/Off contrast is always a larger number than ANSI contrast for the same projector.

dB— decibel—A unit used to express relative difference in power or intensity, usually between two acoustic or electric signals, equal to ten times the common logarithm of the ratio of the two levels.

Diagonal Screen— A method of measuring the size of a screen or a projected image. It measures from one corner to the opposite corner. A 9FT high, 12FT wide, screen has a diagonal of 15FT. This document assumes that the diagonal dimensions are for the traditional 4:3 ratio of a computer image as per the example above.

DLP— Digital Light Processing—Reflective display technology developed by Texas Instruments, using small manipulated mirrors. Light passes through a color filter is sent to the DLP mirrors which arrange the RGB colors into a picture projected onto screen, also known as DMD.

DMD— digital Micro- Mirror Device— Each DMD consists of thousands of tilting, microscopic aluminum alloy mirrors mounted on a hidden yoke.

DVI— Digital Visual Interface— Defines the digital interface between digital devices such as projectors and personal computers. For devices that support DVI, a digital to digital connection can be made that eliminates the conversion to analog and thereby delivers an unblemished image.

Focal Length— The distance from the surface of a lens to its focal point.

Frequency— It is the rate of repetition in cycles per seconds of electrical signals. Measured in Hz.

Hz — Frequency of an alternating signal. See Frequency.

Keystone Correction— Device that will correct an image of the distortion (usually a wide-top narrow-bottom effect) of a projected image caused by improper projector to screen angle.

Laser Pointer— A small pen or cigar sized pointer that contains a small battery powered laser, which can project a small, red (typically), high intensity beam of light that is immediately very visible on the screen.

Maximum Distance— The distance from a screen the projector can be to cast an image that is useable (bright enough) in a fully darkened room.

Maximum Image Size— The largest image a projector can throw in a darkened room. This is usually limited by focal range of the optics.

Metal Halide Lamp— The type of lamp used in many medium and all high end portable projectors. These lamps typically have a "half-life" of 1000-2000 hours. That is they slowly lose intensity (brightness) as they are used, and at the "half-life" point, they are half as bright as when new. These lamps output a very "hot" temperature light, similar to mercury vapor lamps used in streetlights.. Their whites are "extremely" white (with slight bluish cast.) and make Halogen lamp's whites look very yellowish by comparison.

Minimum Distance— The closest position that a projector can focus an image onto a screen.

NTSC— The United States broadcast standard for video and broadcasting.

PAL— A European and international broadcast standard for video and broadcasting. Higher resolution than NTSC.

Power Zoom— A zoom lens with the zoom in and out controlled by a motor, usually adjusted from the projector's control panel and also the remote control.

Reverse Image— Feature that allows you to flip the image horizontally. When used in a normal forward projection environment text, graphics, etc, are backwards. Reverse image is used for rear projection.

RGB— Red, Green, Blue— typically used to describe a monitor that requires separate signals for each of the three colors.

S-Video—A video transmission standard that uses a 4-pin mini-DIN connector to send video information on two signal wires called luminance (brightness, Y) and chrominance (color, C). S-Video is also referred to as Y/C.

SECAM— A French and international broadcast standard for video and broadcasting. Higher resolution than NTSC.

SVGA— Super Video Graphics Array— 800 x 600 pixels count.

SXGA— Super Ultra Graphics Array,—1280 x 1024 pixels count.

UXGA— Ultra Extended Graphics Array—1600 x 1200 pixels count.

VGA— Video Graphics Array—640 x 480 pixels count.

XGA— Extra Video Graphics Array— 1024 x 768 pixels count.

Zoom Lens— Lens with a variable focal length that allows operator to move the view in or out making the image smaller or larger.

Zoom Lens Ratio— Is the ratio between the smallest and largest image a lens can project from a fixed distance. For example, a 1.4:1 zoom lens ratio means that a 10 foot image without zoom would be a 14 foot image with full zoom.

Index

A

- Adjusting Projection Image Size 35
- Adjusting the Projected Image 15
 - Adjusting the Projector Height 15
 - lower the projector
 - Elevator button 15
 - Elevator foot 15
 - Tilt adjustment wheel 15
- Adjusting the Projector Zoom and Focus 16
 - Focus ring 16
 - Zoom tab 16

C

- Changing the Lamp 35
- Connecting a Computer with a RS232 cable 13
- Connecting the Projector
 - Composite video cable 11
 - Connecting with a Component Cable 12
 - Connecting with a Composite Cable 11
 - Connecting with an S-video Cable 10
 - D-sub to D-sub cable 9
 - D-sub to YPbPr cable 12
 - Power cord 9, 10, 11, 12, 13

- RS232 cable 13
- S-video cable 10
 - To Computer 9
 - USB to USB cable 9

Connection Ports

- Audio input connector 8
- Audio output connector 8
- Composite video connector 8
- IR receiver 8
- Kensington lock hole 8
- Power cord connector 8
- RS232 connector 8
- S-video connector 8
- USB remote connector 8
- VGA in (D-sub) connector 8
- VGA out (monitor loop-through) 8

Contact Dell 5, 19, 33, 34, 35

Contacting Dell 42

Control Panel 18

D

- Dell
 - Contacting 42

M

Main Unit 7

- Control panel 7
- Elevator button 7
- Focus ring 7
- Lens 7
- Remote control receiver 7
- Zoom tab 7

O

- On-Screen Display 21
 - Auto-Adjust 22
 - DISPLAY (in PC Mode) 25
 - DISPLAY (in Video Mode) 26
 - Input Select 22
 - LAMP 26
 - LANGUAGE 27
 - Main Menu 22
 - PICTURE (in PC Mode) 24
 - PICTURE (in Video Mode) 24
 - Preferences 28
 - Set Up 22

P

- Phone numbers 42
- Powering On/Off the Projector
 - Powering Off the Projector 14
 - Powering On the Projector 14

R

- Remote Control 20

S

- Specifications
 - Audio 37
 - Brightness 37
 - Color Wheel Speed 37
 - Compatibility Modes 40
 - Contrast Ratio 37
 - Dimensions 38
 - Displayable Color 37
 - Environmental 38
 - H. Frequency 37
 - I/O Connectors 38
 - Lamp 37
 - Light Valve 37
 - Noise Level 38
 - Number of Pixels 37
 - Power Consumption 37
 - Power Supply 37
 - Projection Distance 37
 - Projection Lens 37
 - Projection Screen Size 37
 - Regulatory 38
 - RS232 Protocol 39
 - Uniformity 37
 - V. Frequency 37
 - Video Compatibility 37
 - Weight 38
- Support
 - Contacting Dell 42

T

- Telephone numbers 42
- Troubleshooting 31

Contact Dell 31